

TECHNICAL SPECIFICATIONS

VOLTS	120	
AMPS	12.5	
WATTS	1500	
HEATER	HIGH	1500 watts
	LOW	750 watts
NO HEATER	19 watts	
LAMPS	TYPE	LED
	WATTS	
	TOTAL WATTS	41 watts
ROTOR MOTOR	2 at 5 watts	
HEIGHT,WIDTH,DEPTH	33" x 43 1/4" x 13 3/4"	
GLASS VIEWING OPENING	22" X 39 5/8"	
GLASS SIZE	22" X 39 5/8"	
SHIPPING SIZE	35 1/4" x 47 1/2" x 15 5/8"	
SHIPPING WEIGHT	125.7 lbs	
	UNIT	109.6 lbs
GLASS FRONT	Included	
PLUG LOCATION	Left Side	
CORD LENGTH	76"	
APPROX. HEATING AREA	400 sq ft	

Amantii

SERIES	MODEL		REV
TRU VIEW	40-TRV-XL-XT		1
SCALE 1"=1'-0"	DATE: 9/19/2019	SHEET 1 OF 1	

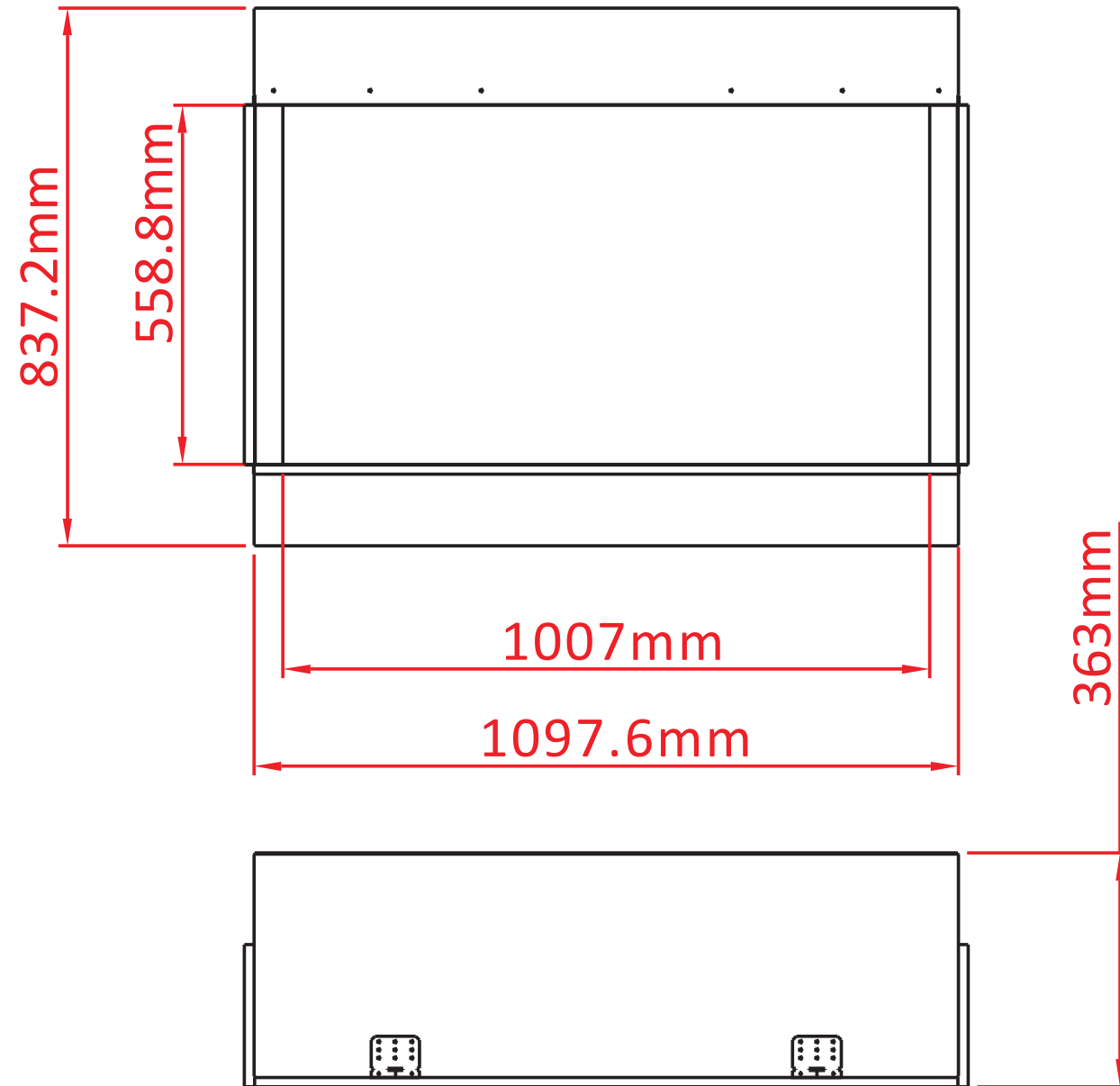

TECHNICAL SPECIFICATIONS

VOLTS	120	
AMPS	12.5	
WATTS	1500	
HEATER	HIGH	1500 watts
	LOW	750 watts
NO HEATER	19 watts	
LAMPS	TYPE	LED
	WATTS	
	TOTAL WATTS	41 watts
ROTOR MOTOR	2 at 5 watts	
HEIGHT,WIDTH,DEPTH	83.7 x 109.8 x 34.8 cm	
GLASS VIEWING OPENING	55.9 X 100.7 cm	
GLASS SIZE	55.9 X 100.7 cm	
SHIPPING SIZE	89.6 x 120.8 x 39.8 cm	
SHIPPING WEIGHT	57 Kgs	
	UNIT	49.7 Kgs
GLASS FRONT	Included	
PLUG LOCATION	Left Side	
CORD LENGTH	193 cm	
APPROX. HEATING AREA	37 sqm	

Amantii

SERIES	MODEL		REV
TRU VIEW	40-TRV-XL-XT		1
SCALE 1:12	DATE: 9/19/2019	SHEET 1 OF 1	