

⚠ IMPORTANT INSTRUCTIONS

When using electrical appliances, basic precautions should always be followed to reduce the risk of fire, electric shock and injury to person, including the following:

1. Read all instructions before using this heater.
2. Do not operate any heater after it malfunctions. Disconnect power at the service panel and have the heater inspected by a reputable electrician before reusing.
3. To disconnect the heater, turn the controls to the OFF position, and turn off the power to the heater circuit at the main disconnect panel.
4. Do not insert or allow foreign objects to enter any ventilation or exhaust opening, as this may cause an electric shock or fire, or damage the heater.
5. To prevent a possible fire, do not block the air intakes or exhaust in any manner.
6. A heater has hot and arcing or sparking parts inside. Do not use it in areas where gasoline, paint, or flammable vapors or liquids are used or stored.
7. Use this heater only as described in this manual. Any other use not recommended by the manufacturer may cause fire, electric shock, or injury to persons.
8. This heater is hot when in use. To avoid burns, do not let bare skin touch hot surfaces. Keep combustible materials, such as furniture, pillows, bedding, papers, clothes, etc. and curtains at least 3 ft. (0.9 m) from the front and sides of the heater.
9. Extreme caution is necessary when any heater is used by or near children or invalids, and whenever the heater is left operating and unattended.
10. Do not use outdoors.
11. Changes or modifications not expressly approved by the party responsible for compliance could void the user's authority to operate the equipment.

SAVE THESE INSTRUCTIONS

This equipment has been tested and found to comply with the limits for a Class B digital device, pursuant to Part 15 of the FCC Rules. These limits are designed to provide reasonable protection against harmful interference in a residential installation. This equipment generates uses and can radiate radio frequency energy and, if not installed and used in accordance with the instructions, may cause harmful interference to radio communications. However, there is no guarantee that interference will not occur in a particular installation. If this equipment does cause harmful interference to radio or television reception, which can be determined by turning the equipment off and on, the user is encouraged to try to correct the interference by one of the following measures:

- Reorient or relocate the receiving antenna.
- Increase the separation between the equipment and receiver.
- Connect the equipment into an outlet on a circuit different from that to which the receiver is connected.
- Consult the dealer or an experienced radio/TV technician for help.

This device complies with Part 15 of the FCC Rules. Operation is subject to the following two conditions: (1) This device may not cause harmful interference, and (2) this device must accept any interference received, including interference that may cause undesired operation.

⚠ FCC CAUTION: Any changes or modifications not expressly approved by the party responsible for compliance could void the user's authority to operate this equipment.

This device complies with Industry Canada licence-exempt RSS standard(s). Operation is subject to the following two conditions: (1) this device may not cause interference, and (2) this device must accept any interference, including interference that may cause undesired operation of the device.

⚠ Installation Instructions

⚠ WARNING: Do not install the heater where the controls can be reached by a person bathing or showering.

⚠ CAUTION: The heater must not be located directly beneath a wall socket outlet.

⚠ CAUTION: The supplied hanging components are designed for use with this heater only. Improper use, or use for purposes other than intended, may cause damage or injury.

1. Remove the mounting bracket from the back of the convactor.
2. Using the mounting bracket as a guide determine the location of the convactor, see Figure 1 for minimum clearances.
3. Attach the mounting bracket securely to the wall using the appropriate hardware (not included) for the mounting surface.
4. Mount the convactor to the mounting bracket.

! NOTE: Ensure that the air can enter and leave the heater freely, through the inlets at the bottom and the outlets at the front.

Electrical Connection

⚠ WARNING: Heater and controls should be installed by a qualified contractor. Wiring procedures and connections

Figure 1

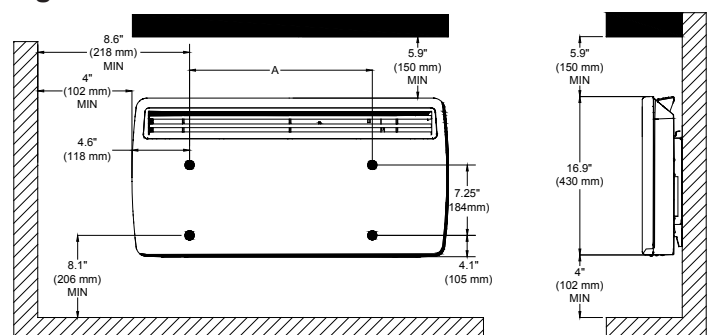

Model	A
PPC0500	4.6 in. (116 mm)
PPC1000	11.2 in. (285 mm)
PPC1500	14.0 in. (356 mm)
PPC2000	20.7 in. (526 mm)

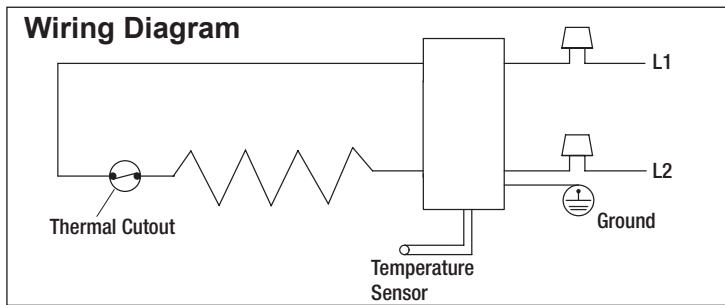

should be in accordance with the National Electric Code (CEC & NEC) and local codes.

Connect the supply wire into a properly rated recess box.

! NOTE: Consult your local electrical code for applicable wire gauge.

Connect L1 from the power supply to the L1 labelled wire from the unit, connect the L2 wire from the power supply to the L2 labelled wire from the unit, and connect the ground to the ground screw on the unit.

Operation

! CAUTION: This panel convector must be properly installed before it is used.

! CAUTION: Prior to energization remove all construction dirt (plaster, sawdust, etc.) from interior and exterior of panel convector.

! CAUTION: Avoid direct contact of paper, fabric, or furniture with panel convector, to prevent a possible fire.

Dimplex panel convectors are designed and tested for safe and trouble-free operation. Free airflow throughout the panel convector is very important for the most efficient operation of the panel convector. All Dimplex panel convectors are protected against overheating by a built-in thermal cutout. A thermal cutout will switch off the heater if for any reason it overheats. Should the cutout operate, disconnect heater from power supply and determine the reason for overheating. Resolve the reason for overheating before attempting to use the heater again. To reset the heater it is necessary to switch off the power to the heater for several minutes.

The PPC features CONNEX™, a wireless technology that works with Dimplex single and multi-zone CONNEX™ controllers to provide simple whole home connectivity and comfort. CONNEX™ controllers are available to control one or multiple CONNEX™ heaters within a 50 ft. (15 m) radius.

When power is first supplied to the PPC the Setpoint Temperature will flash in the temperature display area. At any time either the **+** or **-** button can be pressed to have the temperature setpoint displayed again.

A. Setting/Temperature Display **88.5**°E

The PPC is designed to control the temperature of a room anywhere from 32-86°F (0-30°C). Pressing the **+** or **-** will increase or decrease the desired temperature for the room to be heated by 0.5° (in either °C or °F).

After 5 seconds the Setpoint Temperature will switch to display the intake temperature of the room.

! NOTE: Pressing the **+** and **-** at the same time will toggle between °C and °F.



B. Economy Setting

The Economy Setting can be used to change the Setpoint

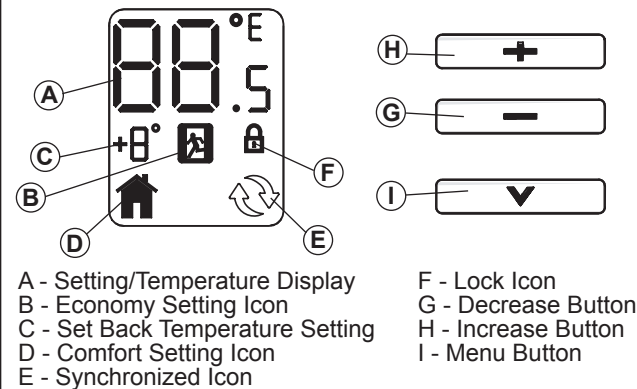
Figure 2



Temperature for a variable period of time. By pressing the **V** the Economy Setting will be enabled - signified by the icon flashing. After the Set Back Temperature has been set, the icon will become solid after three seconds and the Set Back Temperature will be enabled.



To return back to the Comfort Setting press the **V** button and the  icon will disappear and the  icon will appear.

C. Set Back Temperature Setting

The Set Back Temperature Setting is used during periods when the Economy setting feature is active. This temperature adjustment can be set by pressing the **V** followed by the **+** or **-**.



D. Comfort Setting

The Comfort Setting icon will be displayed when the heater is in normal operation based on the Setpoint Temperature for the room.

! NOTE: Either the  or  icon will always be visible, dependent on the setting being used.

E. Synchronized Icon

The PPC and the controller will need to be synchronized, to operate together. To do this:

1. On the PPC heater press and hold the **V** button for 3 seconds, both the  and  icons will begin to flash.
2. Press the **-**, **+** and then **V**, on the PPC heater.
3. Within 10 seconds press any button once on the CONNEX™ controller.

! NOTE: There is a 3 second delay between pressing the last button the CONNEX™ controller and the PPC heater.

! NOTE: To desynchronize a PPC heater from the synchronized CONNEX™ controller, on the PPC heater:

1. Press and hold the **V** for 3 seconds.
2. Press the **V**, **+** and then **-**.





Nothing needs to be done to the CONNEX™ controller.

Dimplex single and multi-zone CONNEX™ controllers are sold separately and are available for purchase from your authorized Dimplex dealer.

To find your local Dimplex dealer, visit www.dimplex.com.

F. Lock Icon

The Panel Proportional Convector Heater has a Button Lock feature, to prevent settings from accidentally being changed.

1. Press and hold the **V** for 3 seconds. Both the  and  icons will begin to flash.
2. **To Enable:** Within 5 seconds press **+**, then **—**, then **+**, then **—**. The  icon will now be visible.
To Disable: Within 5 seconds press **—**, then **+**, then **—**, then **+**. The  icon will not be visible.

! NOTE: The PPC can be locked in either the Comfort or Economy Setting. Ensure that the desired icons are present when locking is complete.

Maintenance

⚠ WARNING: Disconnect power and allow the unit to completely cool before attempting any maintenance or cleaning to reduce the risk of fire, electric shock, or damage to persons.

⚠ CAUTION: The heater should not be operated with an accumulation of dust or dirt on or in the unit, as this can cause a build up of heat and eventual damage. For this reason the heater must be inspected regularly, depending upon conditions and at least at yearly intervals.

The outer surface can be wiped with a soft damp cloth.

! NOTE: Do not use scouring powder or furniture polish, as these can damage the surface.

Dust that collects within the unit can be removed from the outside using a vacuum cleaner.

Warranty

The Manufacturer warrants the convector heater and components of the enclosed product against any defect in material or workmanship for a period of **two years** from the date of purchase, with the exception of the elements which are warranted to be free from defect in material and workmanship for **ten years**. In full satisfaction of any claims under this Warranty the Manufacturer will repair or replace without charge, in its factory or in the field as it alone may decide, any parts which in its opinion are defective.

The Manufacturer shall not be responsible for any transportation or shipping costs in relation to such repair or replacement except as specifically assumed by it. Misuse of this product or repairs by persons other than the Manufacturer's authorized personnel without the Manufacturer's written approval, will void this Warranty.

This Warranty is in lieu of all other warranties or conditions whether expressed or implied including but not limited to those of merchantability or fitness for purpose and shall constitute the sole remedy of the Purchaser and the sole liability of the Manufacturer in respect of the sale of the product, whether in the nature of breach or breach of fundamental term, or of negligence or otherwise.

The Manufacturer shall not be liable for any special, indirect or consequential damages or for any damages resulting from removal or replacement of a convector heater subject to warranty claim without the Manufacturer's authorization.

Any claims under this Warranty must be submitted in writing to the Service Manager, Dimplex North America Ltd., 1367 Industrial Rd., Cambridge, Ontario N1R 7G8, Canada.

Replacement Parts

1. Display Board	6001880100RP
2. Sensor Assembly	2500750100RP
3. Power Board Assembly	6001870100RP
4. Mounting Bracket	
500W Heater	PPC500MBKT-RP
1000W Heater	PPC1000MBKT-RP
1500W Heater	PPC1500MBKT-RP
2000W Heater	PPC2000MBKT-RP



1367 Industrial Road • Cambridge ON Canada N1R 7G8
1-888-346-7539 • www.dimplex.com

In keeping with our policy of continuous product improvement, we reserve the right to make changes without notice.
© 2015 Dimplex North America Limited